

# AT Brakes & Clutches Complete Brake Repair – On the Shaft, Sizes 25, 55, 115

P-1406  
819-0335

Installation Instructions

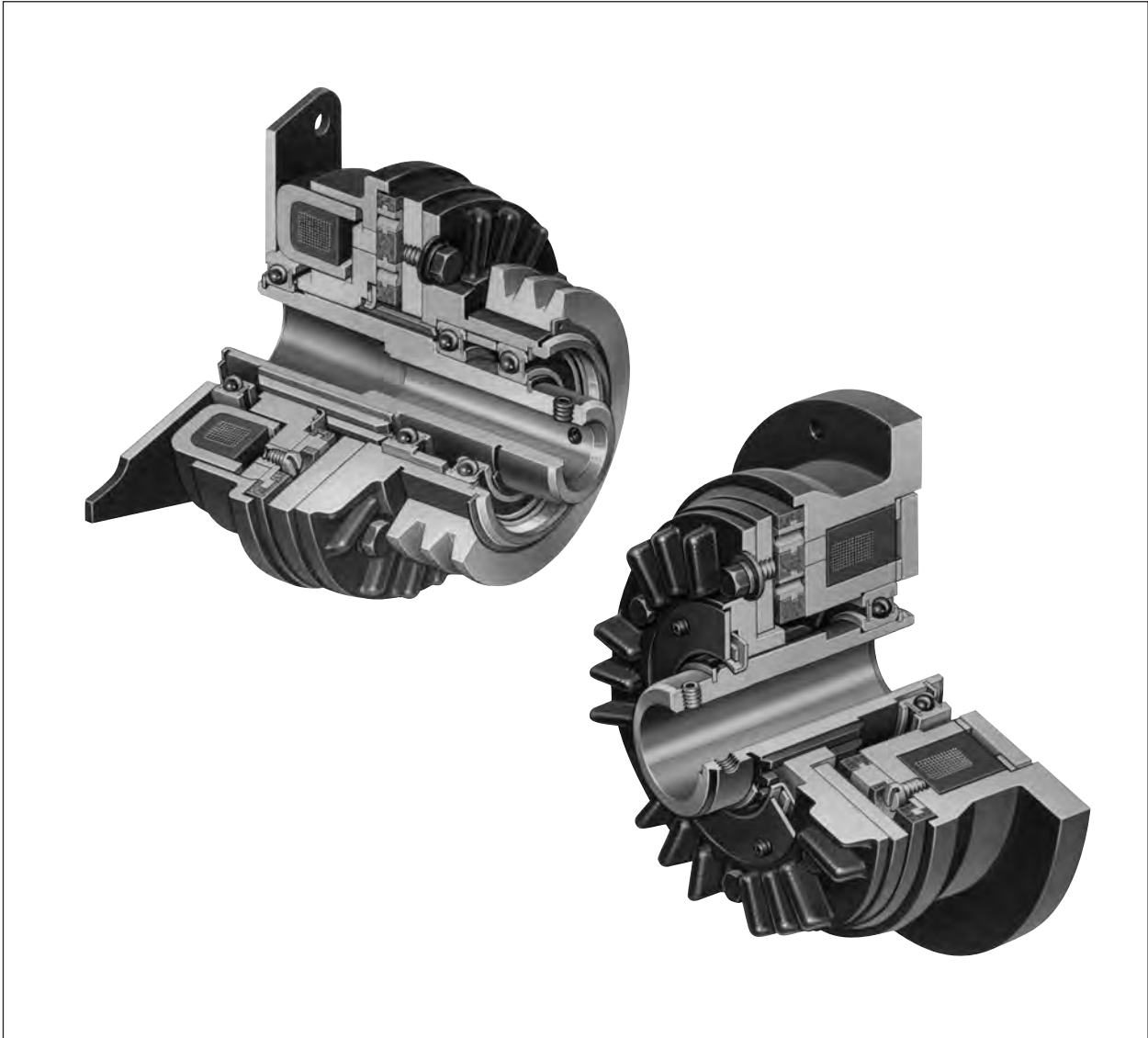

## Contents

Brake Repair ..... 2  
 Warranty..... back cover

**⚠ WARNING** Failure to follow these instructions may result in product damage, equipment damage, and serious or fatal injury to personnel.

## Complete Brake Repair - On the Shaft

The new AT design incorporates the latest in advanced technology providing a rugged, durable, patented design for long life, high cycle rates and maximum heat dissipation. Patented, easy to replace, friction surfaces extend the design life for continued like-new performance. The AT offers complete repair on the shaft following ten easy steps. The repair can be completed utilizing the parts in the friction face replacement kit. The unit shown is a brake, but steps apply equally to clutch repair.

1. Move the brake or clutch armature away from the magnet or field for disassembly and reassembly.

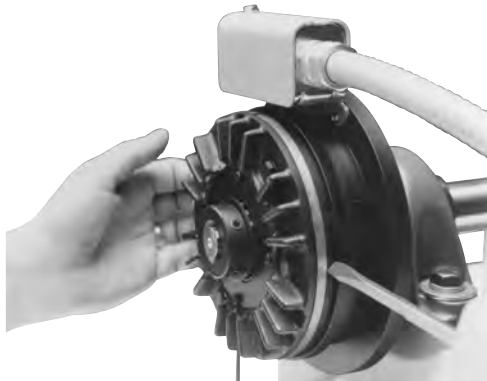

2. Remove hex head cap screws, washers and lock washers to loosen the armature segments from the cast iron carrier.

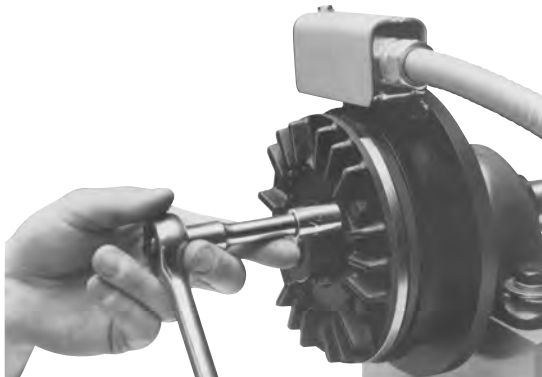

3. Lift out the two worn armature segments.

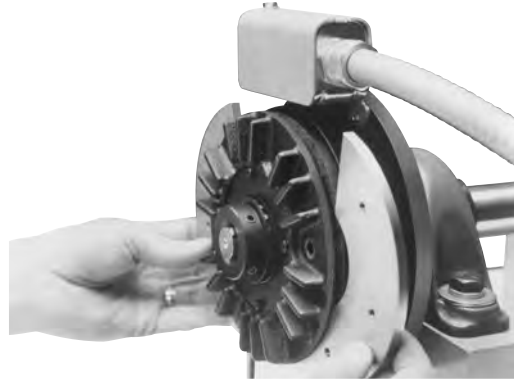

4. Remove the screws that attach the friction material segments to the brake magnet or clutch rotor through the appropriate access holes.

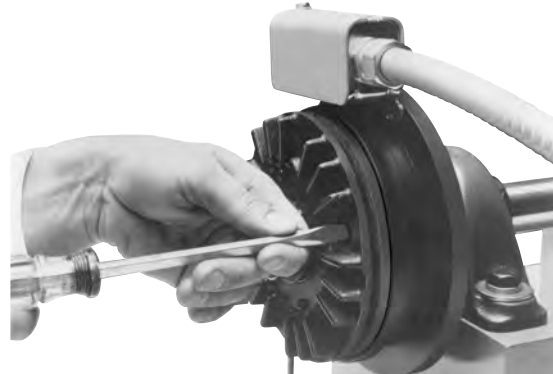

5. Lift out the worn friction material segments. Assure that the autogap plate, detent ring and spring remain in place on the clutch units during this step.

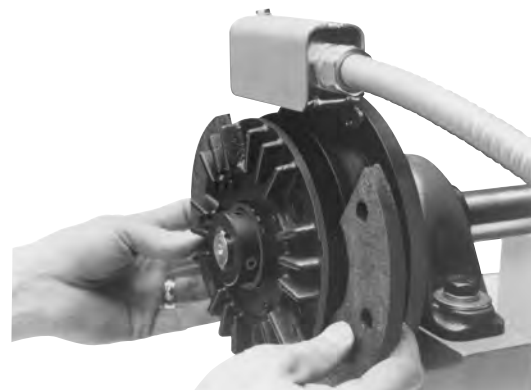

6. Insert two new friction material segments. The recessed holes should be facing away from the magnet body.



7. Attach the new friction material segments to the brake magnet or clutch rotor with the screws through the appropriate access holes. Apply one drop of Loctite (grade AA or equivalent) to each screw.

**Note:** Use only the screws included with the repair kit since any other screws may damage the unit. Tighten screws to 18 to 22 inch pounds torque.

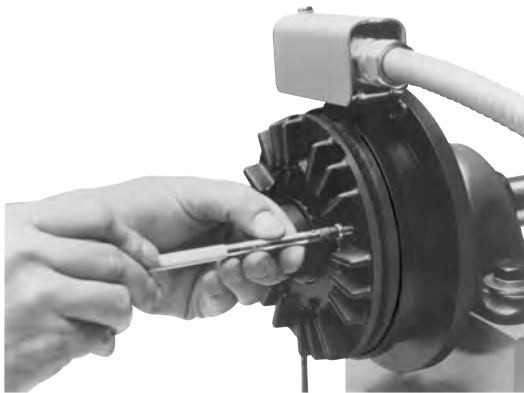

8. Insert the two new armature segments.

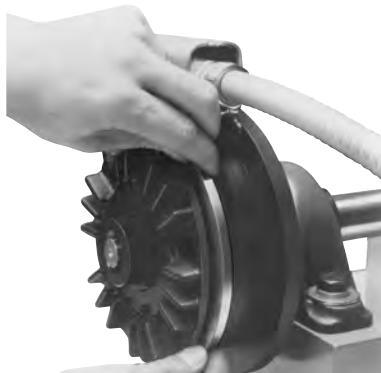

9. Attach the new armature segments to the cast iron carrier with hex head cap screws, lock washers and washers. Apply one drop of Loctite (grade AA or equivalent) to each screw. Tighten to the appropriate torque for your size unit.

Size	Torque
AT 25	29-35 in.lbs.
AT 55	60-84 in.lbs.
AT 115	60-84 in.lbs.

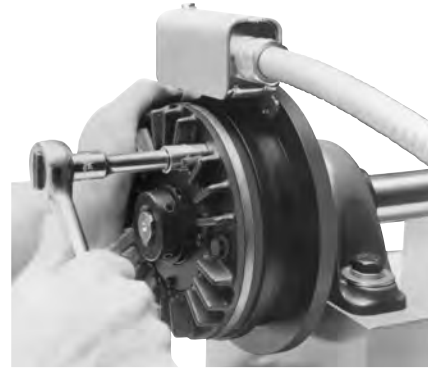

10. Reset the Autogap by pressing the armature toward the magnet or rotor.



11. Your AT clutch or brake is now ready for its static test. Apply DC voltage to the coil through the control. The armature should pull against the friction material face with an audible "click."
12. Run the brake or clutch under its operating load.
13. Your AT brake or clutch may not achieve its full torque until after a short "break-in" period. To break in, cycle it on and off under full load at operating speed a minimum of ten times in quick succession.

Your AT brake or clutch is now ready to run.

## Warranty

Warner Electric LLC warrants that it will repair or replace (whichever it deems advisable) any product manufactured and sold by it which proves to be defective in material or workmanship within a period of one (1) year from the date of original purchase for consumer, commercial or industrial use.

This warranty extends only to the original purchaser and is not transferable or assignable without Warner Electric LLC's prior consent.

Warranty service can be obtained in the U.S.A. by returning any defective product, transportation charges prepaid, to the appropriate Warner Electric LLC factory. Additional warranty information may be obtained by writing the Customer Satisfaction Department, Warner Electric LLC, 449 Gardner Street, South Beloit, Illinois 61080, or by calling 815-389-3771.

A purchase receipt or other proof of original purchase will be required before warranty service is rendered. If found defective under the terms of this warranty, repair or replacement will be made, without charge, together with a refund for transportation costs. If found not to be defective, you will be notified and, with your consent, the item will be repaired or replaced and returned to you at your expense.

This warranty covers normal use and does not cover damage or defect which results from alteration, accident, neglect, or improper installation, operation, or maintenance.

Some states do not allow limitation on how long an implied warranty lasts, so the above limitation may not apply to you.

Warner Electric LLC's obligation under this warranty is limited to the repair or replacement of the defective product and in no event shall Warner Electric LLC be liable for consequential, indirect, or incidental damages of any kind incurred by reason of the manufacture, sale or use of any defective product. Warner Electric LLC neither assumes nor authorizes any other person to give any other warranty or to assume any other obligation or liability on its behalf.

WITH RESPECT TO CONSUMER USE OF THE PRODUCT, ANY IMPLIED WARRANTIES WHICH THE CONSUMER MAY HAVE ARE LIMITED IN DURATION TO ONE YEAR FROM THE DATE OF ORIGINAL CONSUMER PURCHASE. WITH RESPECT TO COMMERCIAL AND INDUSTRIAL USES OF THE PRODUCT, THE FOREGOING WARRANTY IS IN LIEU OF AND EXCLUDES ALL OTHER WARRANTIES, WHETHER EXPRESSED OR IMPLIED BY OPERATION OF LAW OR OTHERWISE, INCLUDING, BUT NOT LIMITED TO, ANY IMPLIED WARRANTIES OF MERCHANTABILITY OR FITNESS.

Some states do not allow the exclusion or limitation of incidental or consequential damages, so the above limitation or exclusion may not apply to you. This warranty gives you specific legal rights and you may also have other rights which vary from state to state.

### Changes in Dimensions and Specifications

All dimensions and specifications shown in Warner Electric catalogs are subject to change without notice. Weights do not include weight of boxing for shipment. Certified prints will be furnished without charge on request to Warner Electric.



**Warner Electric LLC**  
449 Gardner Street • South Beloit, IL 61080  
815-389-3771 • Fax: 815-389-2582  
www.warnerelectric.com